

# 13751681 Arabian Arch Instructions

©2016 Oriental Trading Company, Inc.

OrientalTrading.com (800)-228-2269

## BEFORE YOU BEGIN ASSEMBLY:

- Check that all materials are included in your kit.
- Please read through the instructions before you begin assembly.
- Make sure that your work area is spacious enough to assemble the item.
- Assembly time should be about 3 hours for three people.
- A ladder will be necessary for assembly.

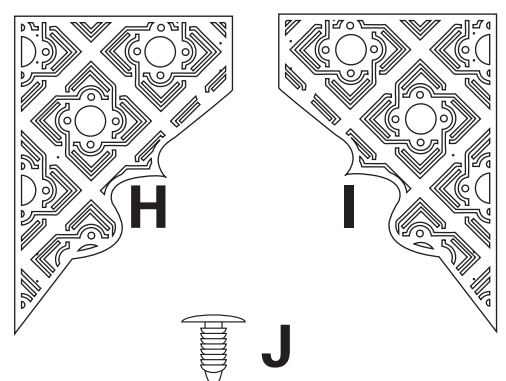
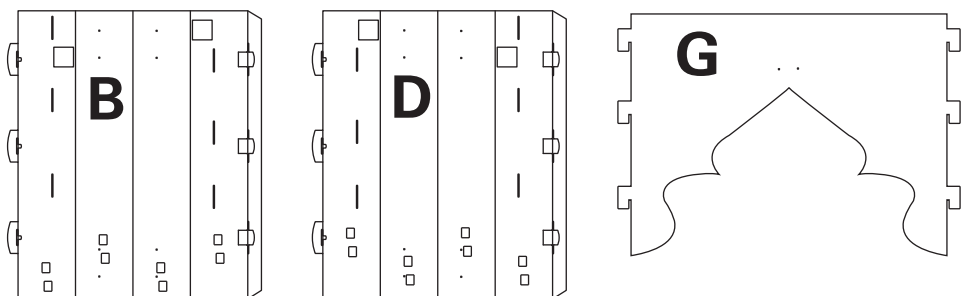
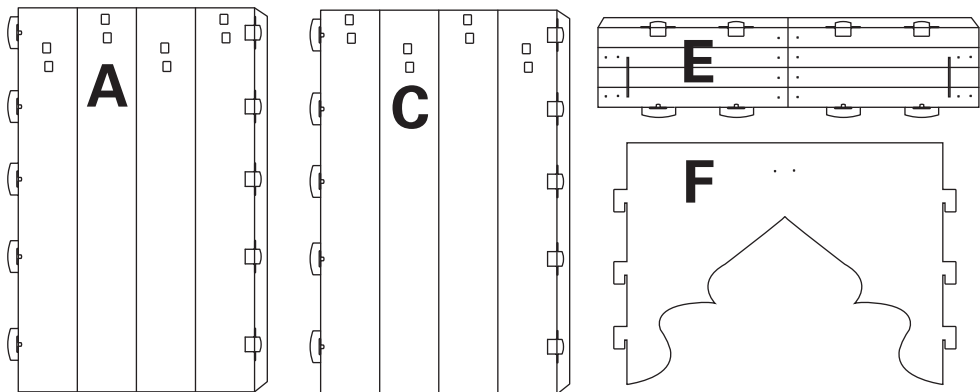

## TOTAL COMPONENTS LIST

QTY.2	A) FRAME BOTTOM POST
QTY.2	B) FRAME TOP POST
QTY.2	C) FRAME BOTTOM POST
QTY.2	D) FRAME TOP POST
QTY.4	E) SUPPORT PIECE
QTY.2	F) SIDE ARCH 1
QTY.2	G) SIDE ARCH 2
QTY.4	H) RIGHT ARCH
QTY.4	I) LEFT ARCH
QTY.64	J) CLEAR PLASTIC PLUGS

## HELPFUL TIPS:

- When folding the pieces make sure the print is facing outward.
- Follow the diagram below to insert and close the tab openings.



## STEP 1:

Fold a Bottom Post (A) along the score lines to form a box shape with the printed side facing out. Fasten the box shape securely by inserting the large and small tabs into the slot openings.

Repeat Step 1 for the other Bottom Posts (A and C).

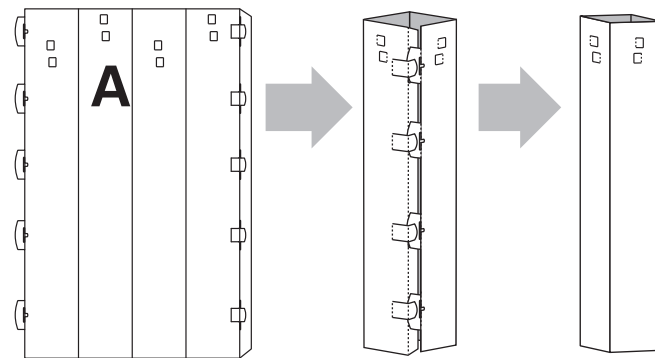

## STEP 2:

Fold a Top Post (B) along the score lines to form a box shape with the printed side facing out. Fasten the box shape securely by inserting the large and small tabs into the slot openings.

Repeat Step 2 for the other Top Posts (B and D).

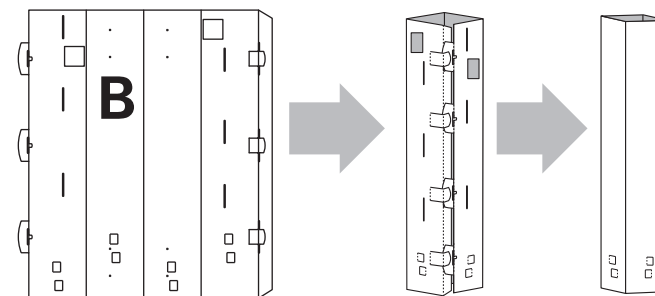

## STEP 3:

Insert the bottom of the Top Post (B) into the opening at the top of the Bottom Post (A). Lock the two posts together by pressing in the square side tabs on all sides.

When assembling the posts, be sure to align the folded seams of the posts.

Repeat Step 3 connecting posts B and A, and D and C.

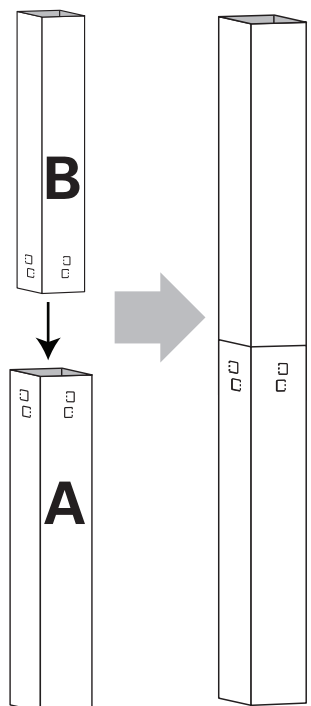

## STEP 4:

Fold a Support Piece (E) along the score lines to form a box shape with the printed side facing out. Fasten the box shape securely by inserting the large and small tabs into the slot openings.

Repeat Step 4 for the other Support Pieces (E).

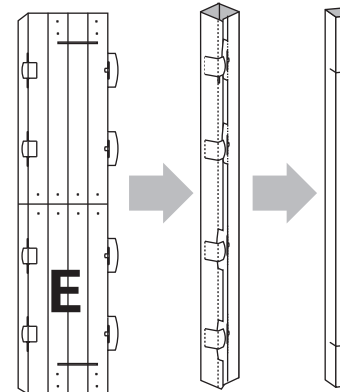

## STEP 5:

Arrange the assembled columns into a square. Make sure the square holes at the top of the columns are the same height.

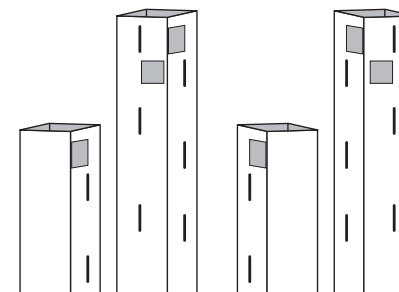

## STEP 6:

Insert the ends of Support Piece (E) into the square holes at the top of two posts to create a brace.

Repeat Step 6 for the other posts and support pieces.

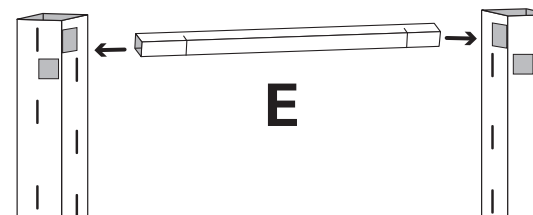

## HELPFUL HINT:

Assemble the archway with the pieces standing up. A ladder will help reach the height of the archway.

## STEP 7:

Insert the notches of the Side Arches F and G. The arches should be on the inside of the square archway. Use two of the Clear Plastic Plugs (J) to secure the arch to the middle of support beam.

Repeat Step 7 for the remaining side arches.

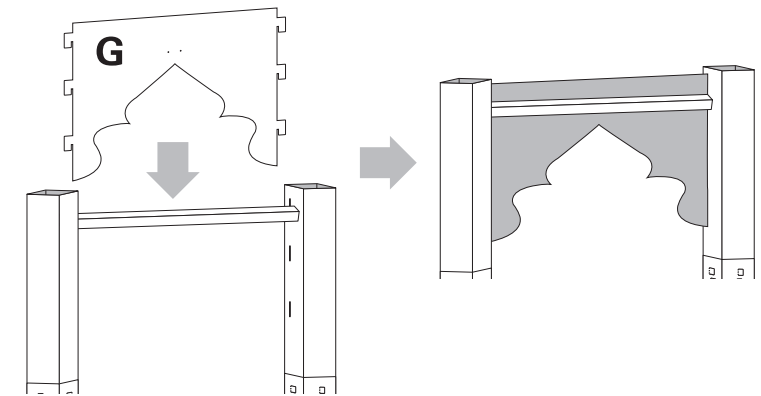

## STEP 8:

Align the Right Arch (H) with the outside top of the structure, use Clear Plastic Plugs (J) secure to the support beam and the columns. Repeat with Left Arch (I)

Repeat Step 8 for the remaining sides of the archway.

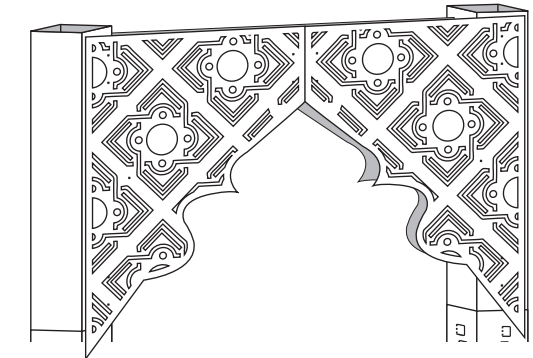

## Your Arabian Archway is finished!

Enjoy your new Arabian Archway!  
Use it as a display piece or as part of a larger scene.

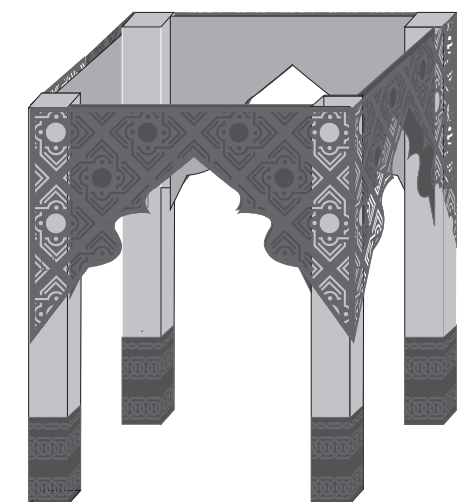

**WARNING!!!**  
THE ARCHWAY IS NOT CAPABLE OF SUSTAINING HEAVY WEIGHTS.