

# 13751689 Arabian Octagon Table Stand-Up Instructions

©2016 Oriental Trading Company, Inc.

OrientalTrading.com (800)-228-2269

## BEFORE YOU BEGIN ASSEMBLY:

- Check that all materials are included in your kit.
- Please read through the instructions before you begin assembly.
- Make sure that your work area is spacious enough to assemble the tables.
- Assembly time should be about 30 minutes for two people.

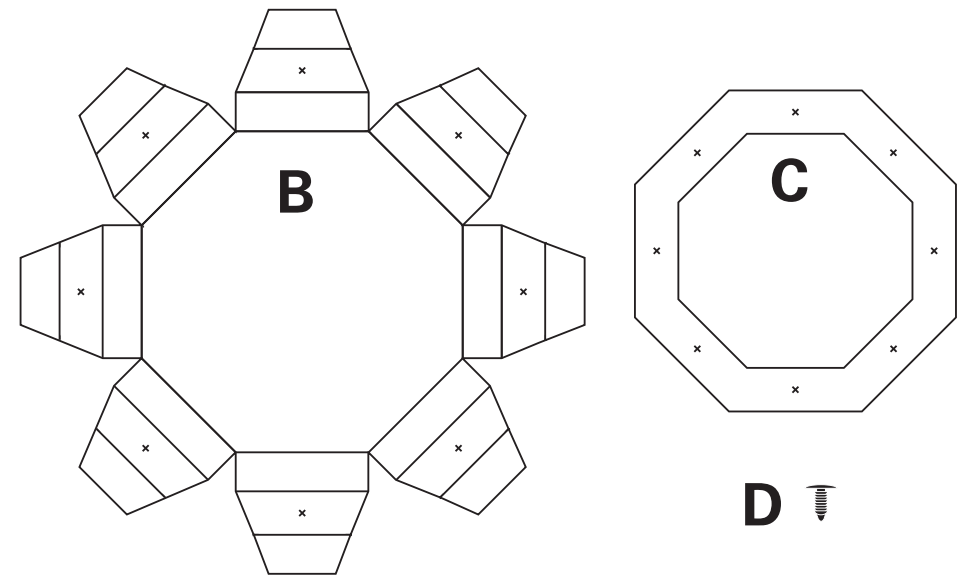
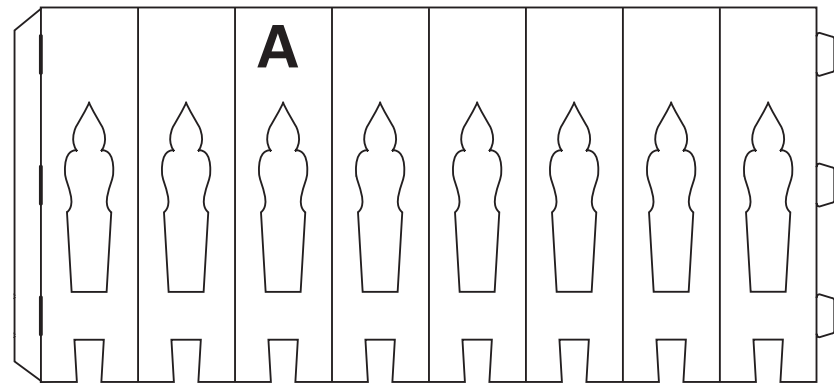

## COMPONENTS LIST

- QTY. 3 A) BASE  
 QTY. 3 B) TABLE TOP  
 QTY. 3 C) TABLE SUPPORT  
 QTY. 30 D) BLACK PLASTIC PLUGS

## STEP 1:

Fold piece A into an octagon shape and secure the tabs.

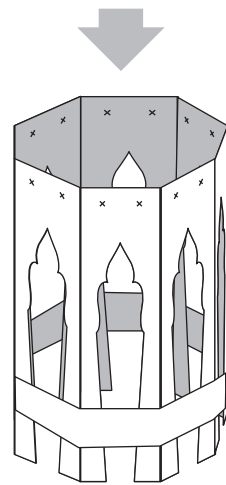
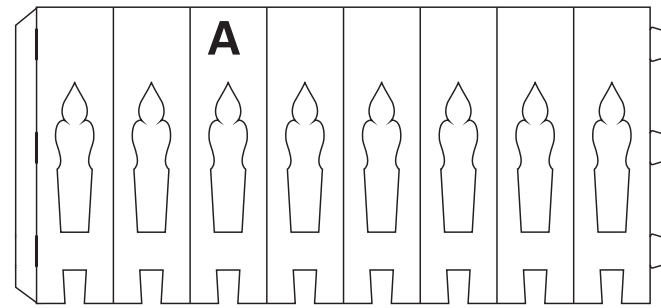

## STEP 2:

Fold the flaps on piece B under to create the table top.

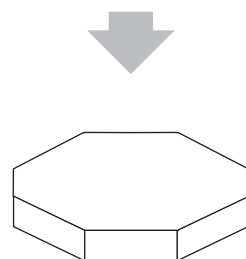
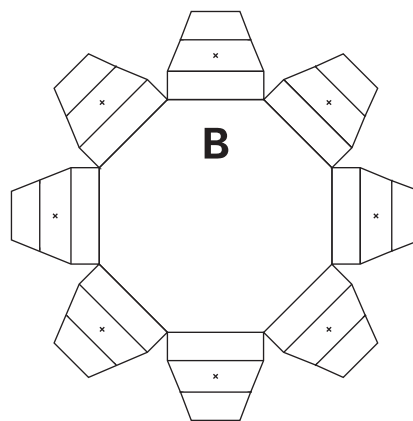

## STEP 3:

Use the plastic plugs to secure piece B to piece C, creating the table top.

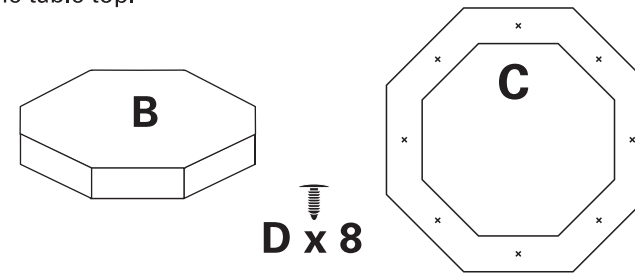

Use the plastic plugs to secure the table top to piece A.

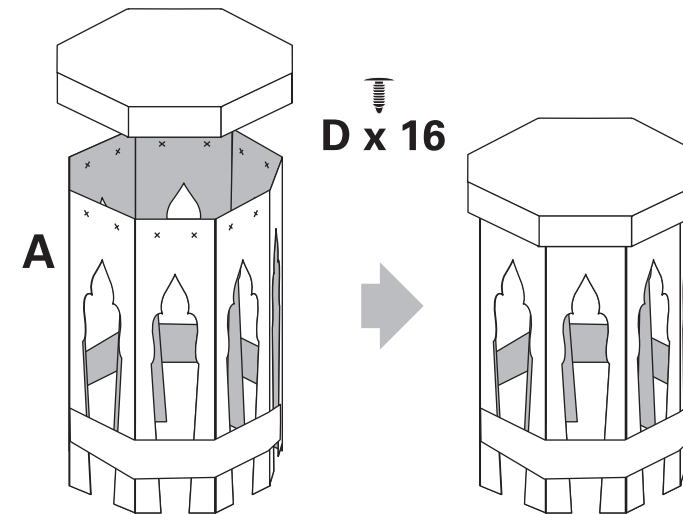

Repeat steps 1-3 to assemble the remaining tables.

## Your Tables are finished!

Enjoy your new tables!

Use them as a display piece or as part of a larger scene.

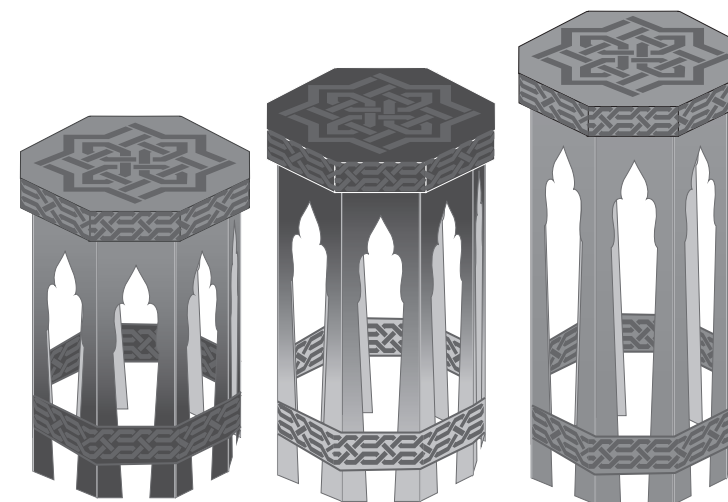

## HELPFUL TIPS:

- When folding the pieces make sure the print is facing outward.
- Follow the diagram below to insert and close the tab openings.

